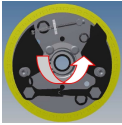

<input type="checkbox"/> Presupuesto Quotation	LIMITADOR DE VELOCIDAD ⚡ OVERSPEED GOVERNOR ⚡ SLC LM12 CD		
<input type="checkbox"/> Pedido Order			
Cliente / Customer	Contacto / Contact	Teléfono / Tel number	PEDIDO LUEZAR-ECO
<input type="text"/>	<input type="text"/>	<input type="text"/>	<input type="text"/>
Fecha pedido / Order date	Nº pedido / Customer order	Referencia cliente / Customer reference	Fecha de entrega / Delivery date
<input type="text"/>	<input type="text"/>	<input type="text"/>	<input type="text"/>

Por favor, marque los productos deseados y complete / Please, mark the products you want and fill in

LM12CD	Cantidad Quantity	<input type="text"/>	Velocidad nominal Rated speed	<input type="text"/>	Velocidad de actuación Tripping speed	<input type="text"/>
---------------	----------------------	----------------------	----------------------------------	----------------------	------------------------------------------	----------------------

Solo en bajada / Only in down direction	Izquierda / Anti-clockwise	Derecha / Clockwise
	<input type="checkbox"/> LM12BI 	<input type="checkbox"/> LM12BD 

Accesorios / Optional parts

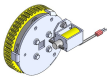
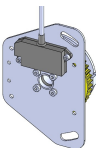

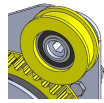
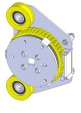
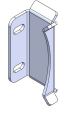
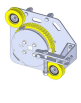
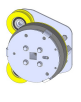

<input type="checkbox"/>	Actuacion a distancia Remote activating	<input type="checkbox"/>	Interior Internal		Tensión Voltage	<input type="text"/>	v
<input type="checkbox"/>	Dispositivo electrónico de seguridad SEL-20 (24Vdc) Electronic safety device SEL-20 (24Vdc) -overspeed protection-	<input type="checkbox"/>	Sin conectores (por defecto) Without connectors (by default)				
		<input type="checkbox"/>	Con conectores With connectors				

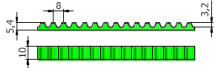
Soporte limitador / Governor support

<input type="checkbox"/>	Tipo 1, low speed sin recuperador con biela Type 1, low speed without recovery with rod		<input type="checkbox"/>	Kit polea guía Belt guide roller	<input type="text"/>	
<input type="checkbox"/>	Tipo 2, Estándar sin recuperador Type 2, Standard without position recovery		<input type="checkbox"/>	Tope fijo antisalida Retainer	<input type="text"/>	
<input type="checkbox"/>	Tipo 4, Estandár con recuperador Type 4, with position recovery					
<input type="checkbox"/>	Tipo 5, low speed sin recuperador Type 5, low speed without position recovery					
<input type="checkbox"/>	Especial Special	<input type="text"/>				

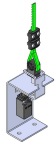
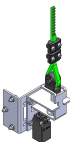
<input type="checkbox"/>	Correa dentada blanca (por defecto) Toothed belt white (by default)	<input type="text"/>	m	
<input type="checkbox"/>	Negra Black			

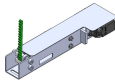
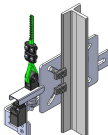
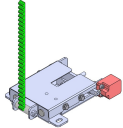
Tensores correa / Toothed belt tensor

Superior	Inferior			Superior	Inferior		
<input type="checkbox"/>	<input type="checkbox"/>	Tensor correa simple Simple tensioner		<input type="checkbox"/>	<input type="checkbox"/>	Tensor correa universal + escuadra Universal tensioner with bracket	
<input type="checkbox"/>	<input type="checkbox"/>	Cabezal tensor eco Eco head tensioner		<input type="checkbox"/>	<input type="checkbox"/>	Tensor correa HFR1 foso reducido Tensioner for reduced pit	
<input type="checkbox"/>	<input type="checkbox"/>	Tensor correa eco a guía Eco tensioner to guide		<input type="checkbox"/>	<input type="checkbox"/>	Tensor correa homelift Tensioner toothed belt Homelift f	
<input type="checkbox"/>	<input type="checkbox"/>	Tensor correa universal Universal tensioner		<input type="checkbox"/>	Especial Special		<input type="text"/>

Posición de montaje (marcar la posición)/ Assembly position

Montaje limitador en chasis PÓRTICO
Assembly in central frame

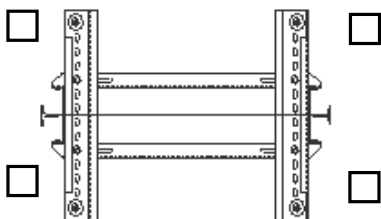

Montaje limitador en chasis MOCHILA
Assembly in back-pack frame

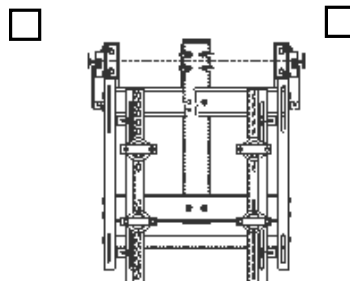

Observaciones

DATOS A RELLENAR POR LUEZAR / To fill in by LUEZAR		
Numero de fabricación	TOMA DE DATOS SLC LM18 CD	Pedido
Edición 15/02/2021	Salvo indicación expresa, los productos suministrados son conforme a la directiva 2014/33/UE Unless otherwise specified, all products are manufactured according to Directive 2014/33/EU	
Fabricado y comercializado por LUEZAR-ECO, S.L., Pol. Malpica, C/F Oeste (Grupo Quejido) Naves 46- 69, 50016 ZARAGOZA (España) Tel. +34 976 570 976 Fax. +34 976 572 126 Email: luezar@luezar.com		